

Flowmeter

TDH...-25.../MS TDI...-25.../MS



Function

The flowmeters type TDH...-25.../MS and TDI...-25.../MS are turbine flowmeters.

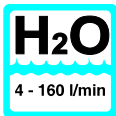

Application

The turbine flowmeters type TDH...-25.../MS and TDI...-25.../MS are employed to measure and monitor volume flow of liquids.

Areas of application:

- Medicine technology
- Pharmaceutical Industry
- Chemical Industry
- Research and Development

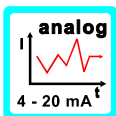
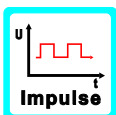
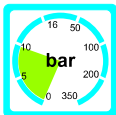
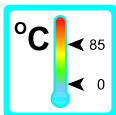

Features

The rotors of the series TDH...-25.../MS are equipped with magnets and a Hall-sensor detects the rotation of the rotor.

The rotors of the series TDI...-25.../MS are equipped with Stainless Steel-pins and an inductive proximity switch detects the rotation.

Further characteristics of both series are:

- Large measuring range
- Sapphire/PA-seating
- High accuracy
- Outputs (alternatively): frequency-, analog- or switch output
- Sturdy Brass-Version

Installation hints

The installation of the flowmeter can be done in any way in the system. The flow direction must be observed.

The flowmeter must not be used as a supporting part in a pipe construction.

The medium must not contain any solids! We recommend the installation of a strainer.

External magnetic fields influence the measurement. Keep sufficient distance to magnetic fields (e.g. electromotors).

The operating instructions for TDH...-25.../MS and TDI...-25.../MS must be observed under any circumstances.

TD -25 /MS 1 0001 04-05 E M

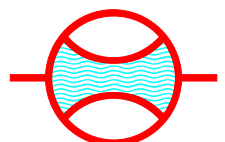

Technical data

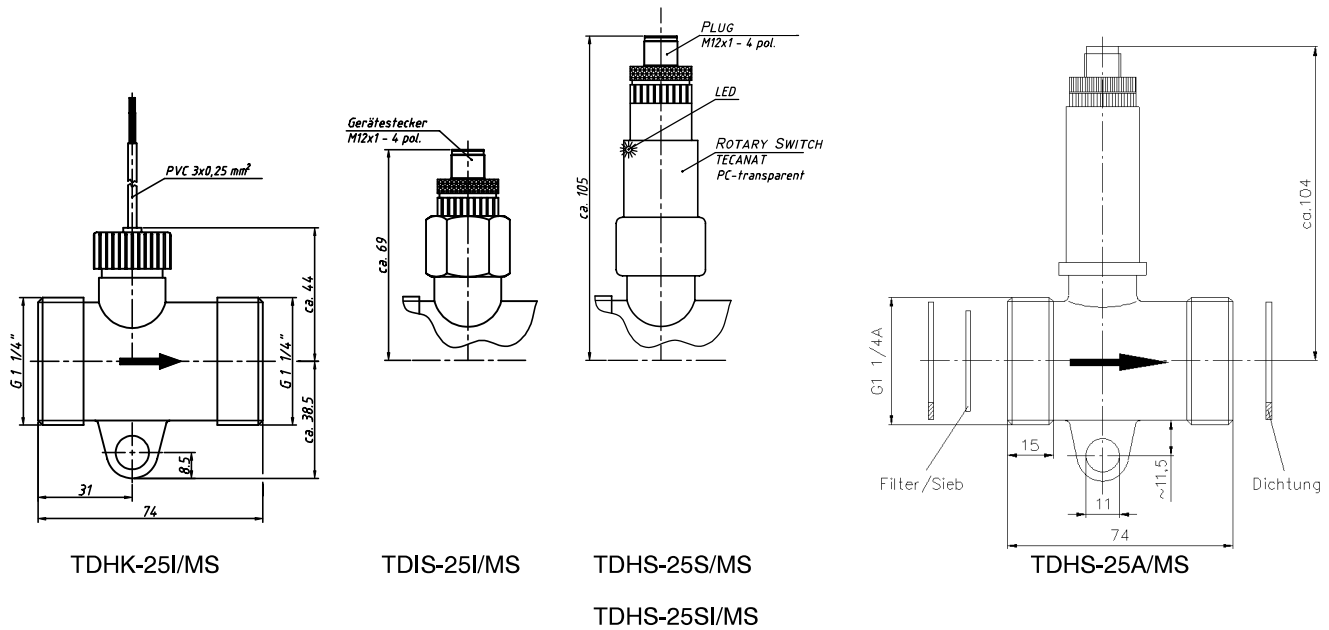

Versions

Type	Measuring value sensing		Output		
	Hall-Sensor	Inductive proximity switch	Impulse output (see page 3)	Analog output (see page 4)	Switch output (see page 4)
TDHK-25I/MS	▲		▲		
TDIS-25I/MS		▲	▲		
TDHS-25S/MS	▲				▲
TDHS-25SI/MS	▲		▲		▲
TDHS-25A/MS	▲			▲	

Technical data

	Units with hall-sensor TDH...	Units with inductive proximity switch TDI...
Process connection:	G 1 1/4" male thread	
	Additional connection fitting absolutely necessary	
Nominal size:	DN 25	
Max. medium temperature:	85 °C	60 °C
Nominal pressure:	PN 10	
Range:	4 - 160 l/min, at continuous load max 80 l/min	
Start of signal output:	1 l/min	
Max. size of solids in medium:	0,5 mm	
Electric connection:		
Cable connection (TDHK...)	2 m shielded PVC-cable	—
	$T_{max} = 75 °C$	—
Plug (TDHS... or TDIS...)	4-Pin-Plug M12x1	4-Pin-Plug M12x1
Power supply (Pulse output):	4,5...24 VDC	12...24 VDC
Ingress protection:	IP 54	
Electric output:	see pages 3 and 4	
Options:		
Strainer	Screen strainer, screen aperture size 0,63 mm	

TD-25/MS 2 0001 04-05 E.M



Materials, Technical data, Signal output

Materials

	Contact with medium?	Units with Hall-Sensor TDH...	Units with inductive proximity sensor TDI...
Measuring tube	yes	Brass (CuZn36Pb2As)	
Turbine chamber	yes	PA Grivory HTV4X1	
Impeller	yes	PP	
Impeller magnets	yes	Permanent magnets, Recona 28 nickel-plated	Stainless Steel 1.4571
Axle	yes	Stainless Steel 1.4436	
Bearing	yes	Saphir / PA	
Sensor bush	yes	POM Delrin 100 P	
O-Ring	yes	72 NBR 872	
Strainer (option)	yes	Stainless Steel 1.4301 (according O-Ring: 70 EPDM 281)	

Technical data impulse output (TDHK-25I/MS, TDIS-25I/MS)

	Units with Hall-Sensor TDH...	Units with inductive proximity sensor TDI...
Accuracy:	± 3 % of range	
Repeatability:	± 0,5 %	
Output signal:		
Pulse rate / K-factor	67 Pulses / Liter	
Resolution	15 ml / Pulse	
Signal form	square wave NPN open collector	square wave PNP open collector
Signal current	max. 100 mA	max. 10 mA
Diagram of connection	A1 (see below)	B1 (see below)
Start of signal output:	1 l/min	

Pulse rate [1/l]

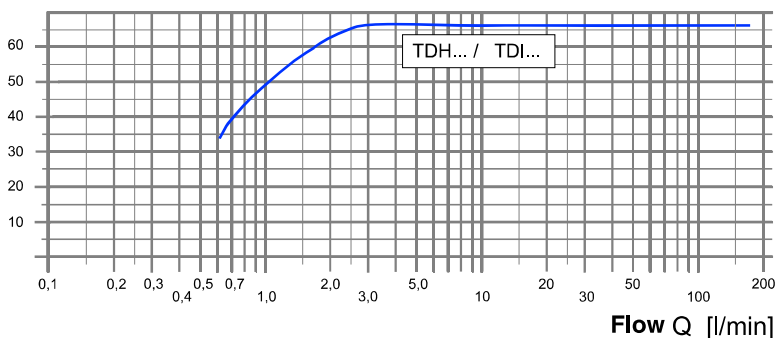

A1: TDHK-25I/MS (Cable)

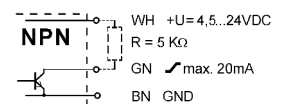

Pressure drop Δp [bar]

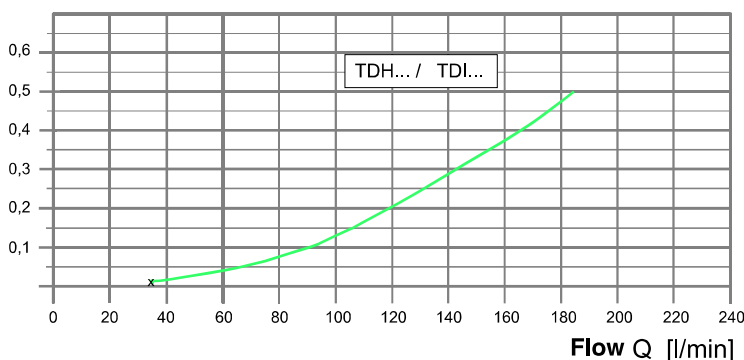

B1: TDIS-25I/MS (PNP, Plug)

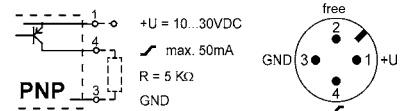

BK = black BN = brown
 BU = blue GN = green
 WH = white

TD-25/MS 3 0001 04-05 E M

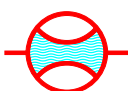

The general business terms of Meister Strömungstechnik GmbH are valid • All rights reserved

Electric output

Technical data analog output (TDHS-25A/MS)

Accuracy:	± 3% of range			
Repeatability:	± 0,5%			
Output signal:	4...20 mA			
Current limit:	approx. 26 mA			
Scale:				
(Please state with order)	0...60 l/min	0...100 l/min	0...160 l/min	
Power supply:	18...30 VDC			
Max. current consumption:	30 mA			
Max. ohmic resistance:	250 Ω against GND			
Residual ripple:	0,2 mA _{SS} through whole scale			
Design:	3-way, galvanically not insulated			
	Combined GND of supply voltage and output signal			
Electric connection:	4-Pin Plug, M12x1			
Ingress protection:	IP 54			
Diagram of connection:	C1			
Max. medium temperature:	85 °C			
Material measuring transducer housing:	Brass			

Technical data Switch output (TDHS-25S/MS) / Switch output + Pulse output (TDHS-25SI/MS)

Switch point setup:	by rotary switch															
Switch point table:																
Switch position	0	1	2	3	4	5	6	7	8	9	A	B	C	D	E	F
Switch point increasing flow [l/min]	3	5	6	8	10	12	15	18	20	25	30	35	40	50	70	100
Switch point decreasing flow [l/min]	5	7	8	10	12	14	17	20	22	27	33	38	44	55	75	105
Accuracy:	± 0,8 l/min ±4 % of selected switch point															
Output:																
TDHS-25S/MS (Switch output only)	potential free contact, opens below setpoint contact rating max. 125 VAC/DC, 100 mA															
TDHS-25SI/MS (Switch output + Pulse output)	Switch output switches against supply voltage contact rating max. 100 mA Impulse output delivers flow proportional frequency signal NPN open collector, max. 10 mA															
Power supply:	12...24 VDC															
Current input:	max. 25 mA															
Ingress protection:	IP 54 with closed hull and attached cable box															
Indication, internal:	LED yellow = ok, LED red = alarm															
Electric connection:	4-Pin Plug, M12x1															
Diagram of connection:	D1 and D2 (see below)															
Max. medium temperature:	80 °C															
Housing material:	Plastic PA, transparent															

C1: TDHS-25A/MS

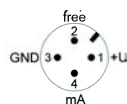
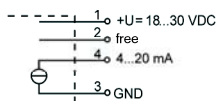

D1: TDHS-25S/MS

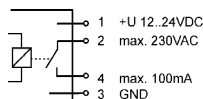

D2: TDHS-25SI/MS

